

## SPM020P-AT

### Multicrystalline Silicon Photovoltaic Module

#### FEATURE:

- TUV certification
- UL certification
- High power module using 6" Multicrystalline solar cell.
- Using low iron tempered glass, EVA laminate TPT backsheet.
- Anodize aluminum frame protected.
- 10 years limited warranty of 90% power output and 25 years limited warranty of 80% power output.
- diodes to avoid power decreasing by shade.



ELECTRICAL CHARACTERISTICS			
	SPM022P-AT	SPM020P-AT	SPM018P-AT
Power at STC (Pm)	22W	20W	18W
Maximum power voltage (Vpm)	18.1V	17.2V	16.5V
Maximum power current (Ipm)	1.24A	1.17A	1.10A
Open circuit voltage (Voc)	22.1V	21.7V	21.0V
Short circuit current (Isc)	1.32A	1.25A	1.1A
Tolerance	±5%	±5%	±5%
Module efficiency	11.4%	10.4%	9.4%
Maximum system voltage	1000V DC		
Standard test conditions	Temperature 25°C, Irradiance 1000W/m <sup>2</sup> , AM=1.5		
Temperature coefficient	Isc: 0.05%/K	Voc: -0.36%/K	Pmax: -0.46%/K

Specifications	
Cell	Multicrystalline silicon solar cell, (156mmx26mm)
No. of cell and connection	36 (2x18)
Dimension	550mm (21.7in) x 350mm (13.8in) x 25mm (0.98in)
Weight	2.8KG

AMBIENT CONDITIONS	
Operating Temperature	-40°C to +85°C
Storage Humidity	<90%

OUT PUT	
Type of output terminal	Junction box+diode + "0" terminal
Cable	Length 3000mm

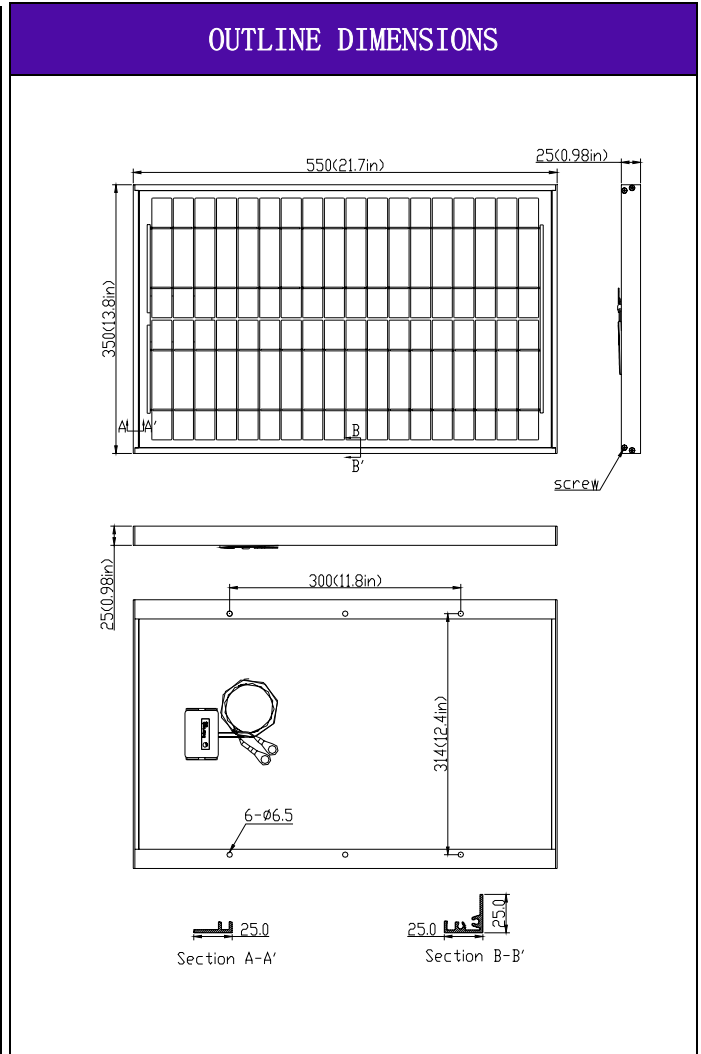
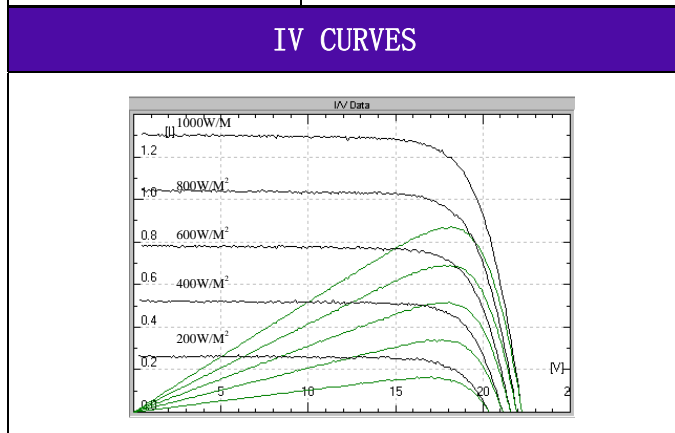

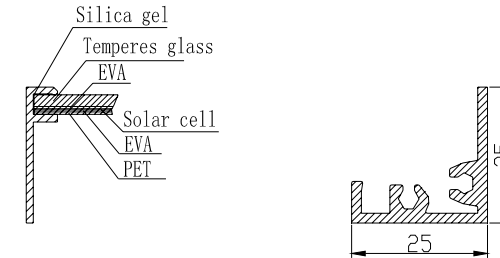
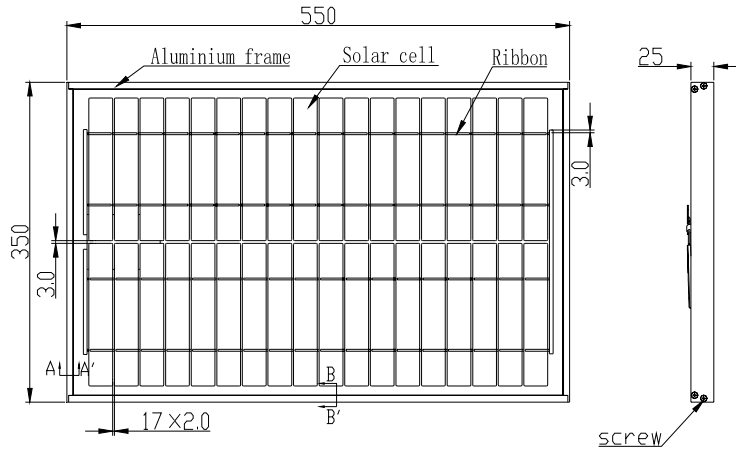

Section A-A'

Section B-B'

Scale 10:1

Electrical data			
Power at stc(p <sub>m</sub> )	22W	20W	18W
Maximum power voltage(V <sub>pm</sub> )	18.1V	17.2V	16.5V
Maximum power current(I <sub>pm</sub> )	1.24A	1.17A	1.10A
Open circuit voltage (V <sub>oc</sub> )	22.1V	21.7V	21.0V
Short circuit current (I <sub>sc</sub> )	1.32A	1.25A	1.1A
Module efficiency	11.4%	10.4%	9.4%

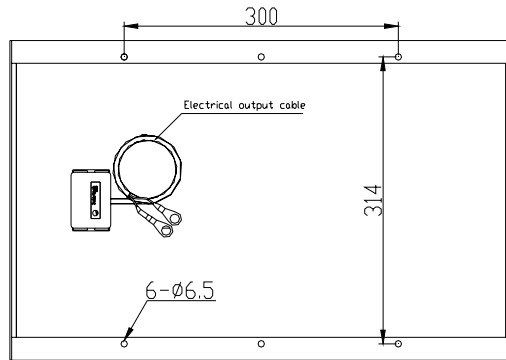
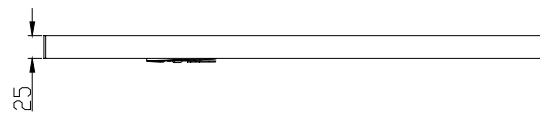

Parts Name	Description	Unit	Quantity
Temperess glass	3.2mm Temperess Glass 546×346	pcs	1
EVA	EAV Film T:0.46MM	M <sup>2</sup>	0.6
Ribbon	60%Sn 40%Pb Ribbon	Kg	0.015
Solar cell	156mm*26mm polycrystalline cell	wp	20
PET	PET Film T:0.25mm	M <sup>2</sup>	0.52
Aluminium frame	25mmx25mm	M	1.4
Screw	Stainless steel 304U	pcs	8
Junction box	*Solartech* Junction Box Cable3000mm+diode+o'terminal	SET	1

XXXX±2	X* ±0.2
XXX ±1	.X* ±0.1
XX ±0.5	.XX*±0.05
X ±0.2	
.XX ±0.1	

 Solartech Power, Inc

UNITS: MM	PART NO: XXX	TITLE: SPM020P-AT PV Module
APPD BY		DWG NO: SPM020P18G002
CHECK BY	DRAWN BY	SCALE SHEET REV. NONE 1/1 A

# Product picture



Front

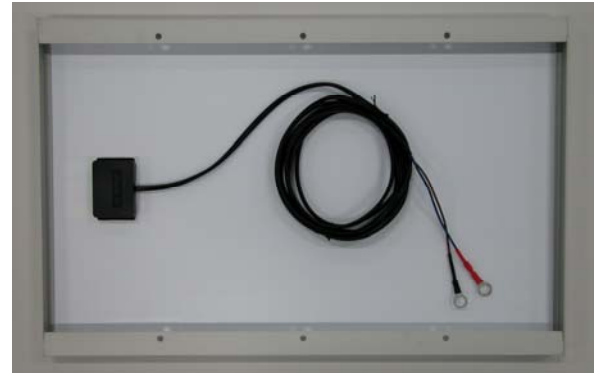

Back



Anodize aluminum



Junction

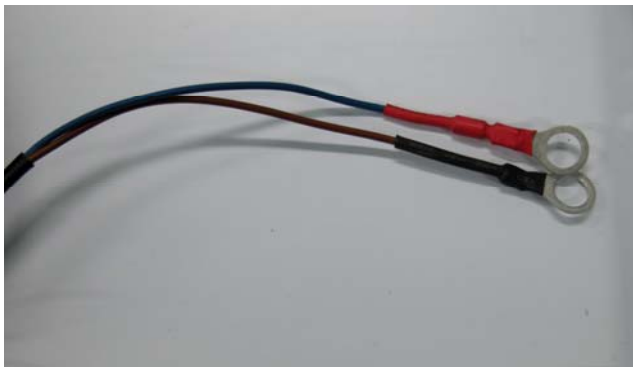

Output terminal