

SPM040P-SM

Multicrystalline Silicon Photovoltaic Module

FEATURE:

- TUV certification
- UL certification
- High power module using 6" Multicrystalline solar cell.
- Using low iron tempered glass, EVA laminate TPE backsheet.
- Anodize aluminum frame protected.
- 10 years limited warranty of 90% power output and 25 years limited warranty of 80% power output.
- 2 diodes to avoid power decreasing by shade



ELECTRICAL CHARACTERISTICS

	SPM045P-SM	SPM040P-SM	
Power at STC(P _m)	45W	40W	
Maximum power voltage(V _{pm})	18.3V	17.3V	
Maximum power current(I _{pm})	2.52A	2.35A	
Open circuit voltage(V _{oc})	22.2V	21.8V	
Short circuit current(I _{sc})	2.69A	2.57A	
Tolerance	±5%	±5%	
Module efficiency	12.6%	11.2%	
Maximum system voltage	1000V DC		
Standard test conditions	Temperature 25°C, Irradiance 1000W/m ² , AM=1.5		
Temperature coefficient	I _{sc} :0.05%/K	V _{oc} :-0.36%/K	P _{max} :-0.46%/K

Specifications

Cell	Multicrystalline silicon solar cell, (156mmx52mm)
No. of cell and connection	36 (4x9)
Dimension	665mm (26.2in)x537mm (21.1in)x35mm (1.38in)
Weight	5.0KG

AMBIENT CONDITIONS

Operating Temperature	-40°C to +85°C
Storage Humidity	<90%

Output

Type of output terminal	Junction box
Cable	Length 900mm

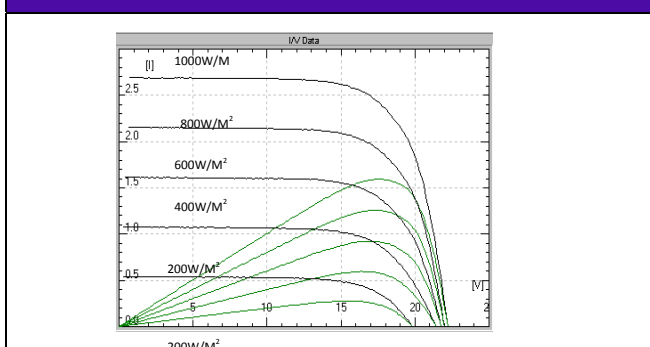
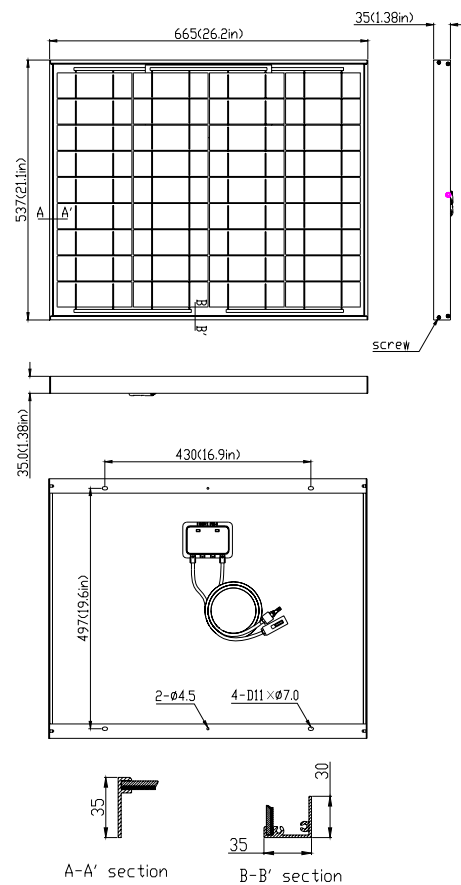
IV CURVES

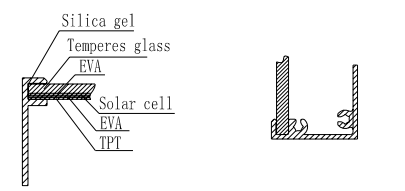
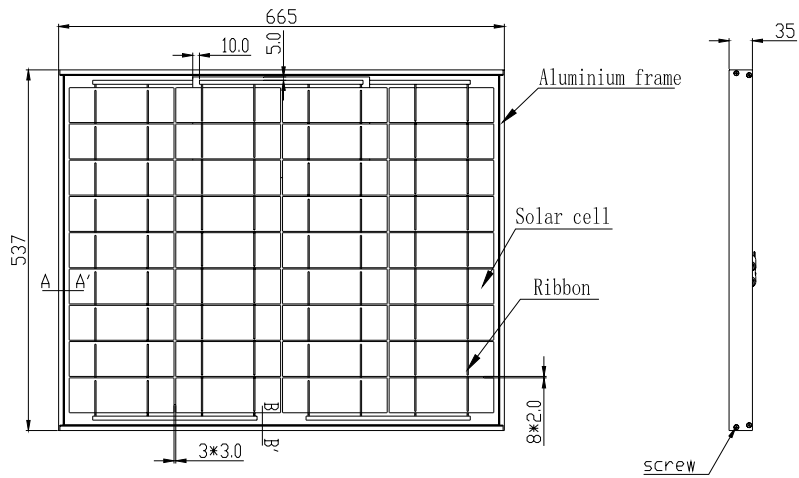
OUTLINE DIMENSIONS

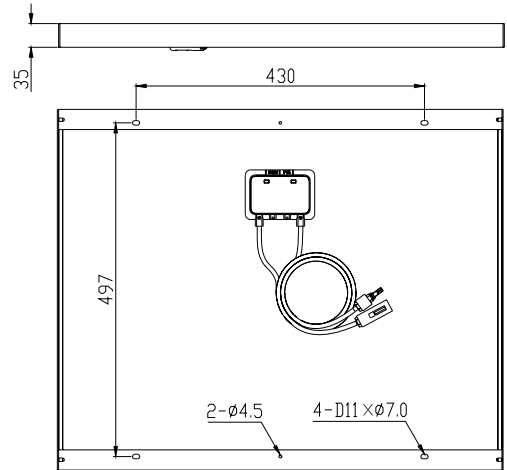

A-A' section B-B' section
Scale 10:1

Electrical data		
Power at stc(pp)	45W	40W
Minimum power voltage(V _{mp})	18.3V	17.3V
Maximum power current(I _{mp})	2.52A	2.35A
Open circuit voltage (V _{oc})	22.2V	21.8V
Short circuit current (I _{sc})	2.69A	2.57A
Module efficiency	12.6%	11.2%



Parts Name	Description	Unit	Quantity
Temperess glass	3.2mm Temperess Glass 661×533	pcs	1
EVA	EAV Film T:0.46MM	M ²	1.0
Ribbon	60%Sn 40%Pb Ribbon	Kg	0.04
Solar cell	156mm×52mm polycrystalline cell	#p	40
TPT	TPE Film T:0.3mm	M ²	0.6
Aluminium frame	35mm×30mm	M	1.8
Screw	Stainless steel 304U	pcs	8
Junction box	Cable:900mm	SET	1

XXXX±2	X* ±0.2		Solartech Power, Inc			
XXX ±1	.X* ±0.1					
XX ±0.5	.XX*±0.05					
X ±0.2						
.XX ±0.1		UNITS: MM PART NO: xxx TITLE: SPM040P-SM PV Module	DWG NO: SPM040PEA2G100			
		APPD BY: CHECK BY: DRAWN BY:		SCALE: NONE	SHEET: 1/1	REV: A

Product picture

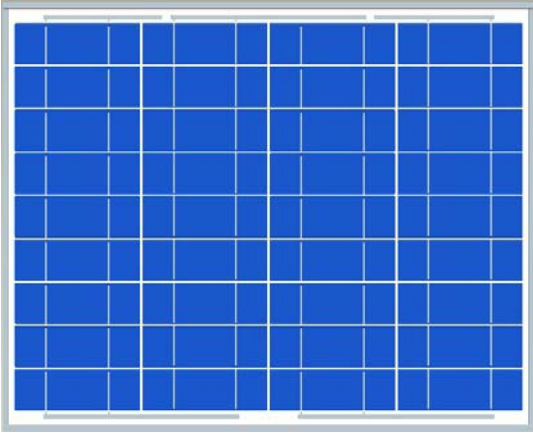

Front

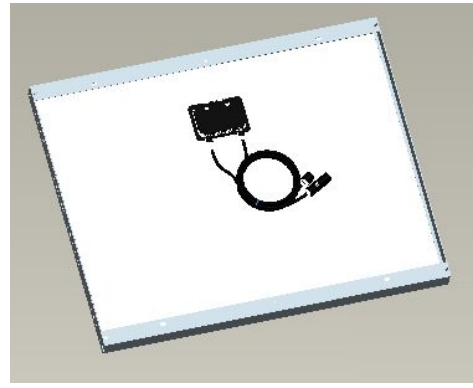

Back

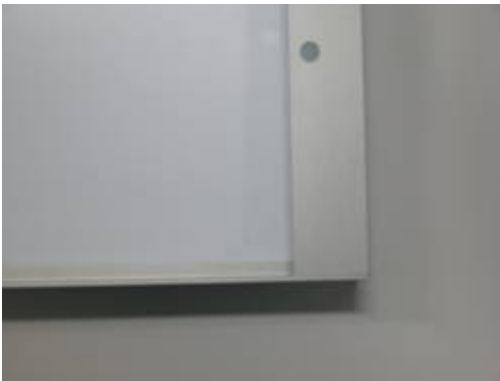

Anodize aluminum



Junction